



# linea xs inground eco

pureWhite | pureColor



USER MANUAL



BEDIENUNGSANLEITUNG

## USER MANUAL

# linea xs inground eco

pureWhite | pureColor

## Safety Instructions



**Devices must be installed by qualified personnel in compliance with all pertaining regulations.**

For your own safety, read all instructions and mounting steps carefully.

Do not attempt to install or use the luminaire until you read and understood the installation instructions and safety labels.

Keep the instructions for maintenance or disassembly work.

The electrical connection may only be carried out by for this purpose trained and authorized personnel.

**WARNING** - Risk of electric shock!

Operate the fixture only with an undamaged lens, housing, or power cables.

The light source (LED module) of this light is not replaceable.

- When the light source reaches its end of life, replace the entire fixture.
- LED module: Risk group 1

## Scope of delivery

- Check completeness of supplied device immediately after receipt.

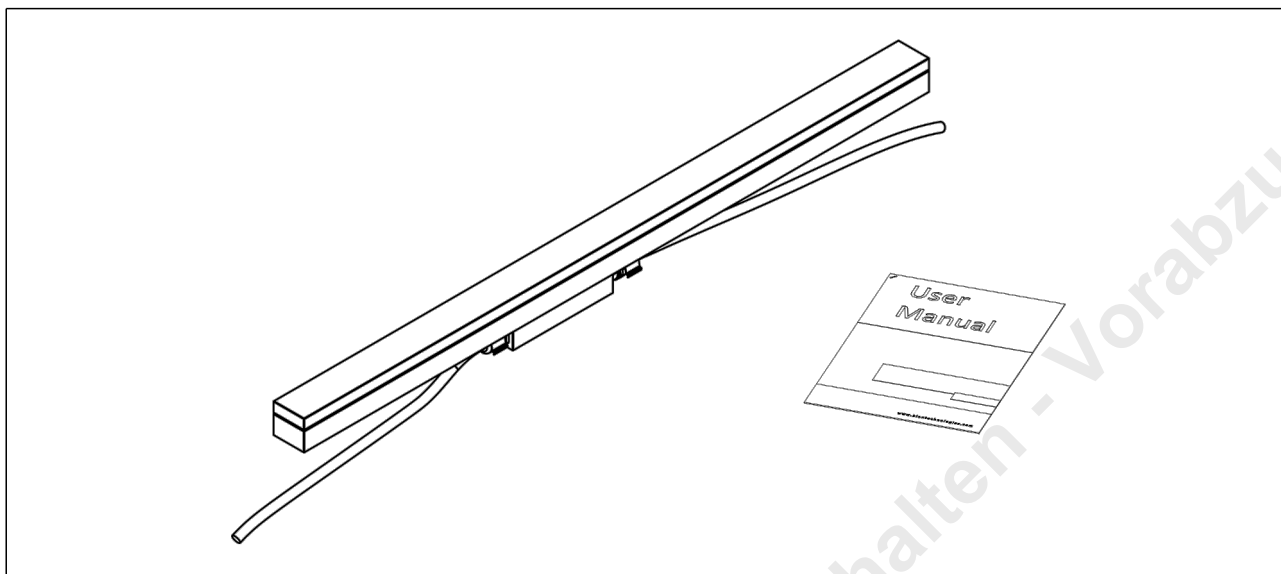









In delivery included:

- 1x Bion Technologies linea xs inground, as specified (specification may differ from the picture above)
- 1x User manual

If you detect any transportation damage or differences between specified packing contents and your unpacked delivery, please contact your dealer immediately.

## Technical Data

Dimensions	46 mm x 74 mm [W x H] 1.81 in x 2.91 in [W x H]		
	Installation housing: 50 mm x 130 mm [W x H] 1.97 in x 5.12 in [W x H]		
Standard Unit Lengths	629 mm, 934 mm, 1239 mm 24.77 in, 36.78 in, 48.78 in		
Fixture Typ	  pureWhite      pureColor		
Color Temperatures pureWhite	2200 K, 2700 K, 3000 K, 3500 K, 4000 K * Project-specific color temperature for pureWhite available.		
LED-Colors pureColor	Red, Green, Blue, Amber * Project-specific colors for pureColor available.		
Beam Angles	8°, 10°, 23°, 43°, 8° x 31° 10° x 42°, 12° x 60°, 14° x 100°, 30° x 60°, 60° x 30°		
Luminous Flux	629 mm (24.77 in): 600 lm 934 mm (36.78 in): 900 lm 1239 mm (48.78 in): 1200 lm		
Light Source	629 mm (24.77 in): 16 LEDs 934 mm (36.78 in): 24 LEDs 1239 mm (48.78 in): 32 LEDs		
Color Rendering Index	R <sub>a</sub> >= 80		
Antiglare	optional: <ul style="list-style-type: none"> <li>▪ Hex louver (internal)</li> <li>▪ Linear louver (internal)</li> </ul>		
LED-Binning			
MacAdam Ellipses Binning	3		
Dimming	Non-dimmable   Dimmable (DALI , 0 - 10 V , DMX)		

Input Voltage	Power supply: external   36 VDC EXT: Constant current, max. 500 mA
Power Consumption	629 mm (24.77 in): Max. 10 W 934 mm (36.78 in): Max. 15 W 1239 mm (48.78 in): Max. 20 W
Protection Class	II
Storage Temperatur	-40 °C / +80 °C   -40 °F / +176 °F
Operating Temperature	-40 °C / +40 °C   -40 °F / +104 °F
Start-up Temperature	-25 °C / +40 °C   -13 °F / +104 °F
Lumen Maintenance [L70]	65'000 h @ 25 °C (77 °F)   40'000 h @ 40 °C (104 °F)
Housing	Aluminum extruded profile
Housing Color(s)	 Black anodized
Lens	Tempered safety glass, extra white
Ingress Protection	IP67
Environment	 indoor  outdoor
Impact Protection	IK09
Certification	  

# Engineering Drawing

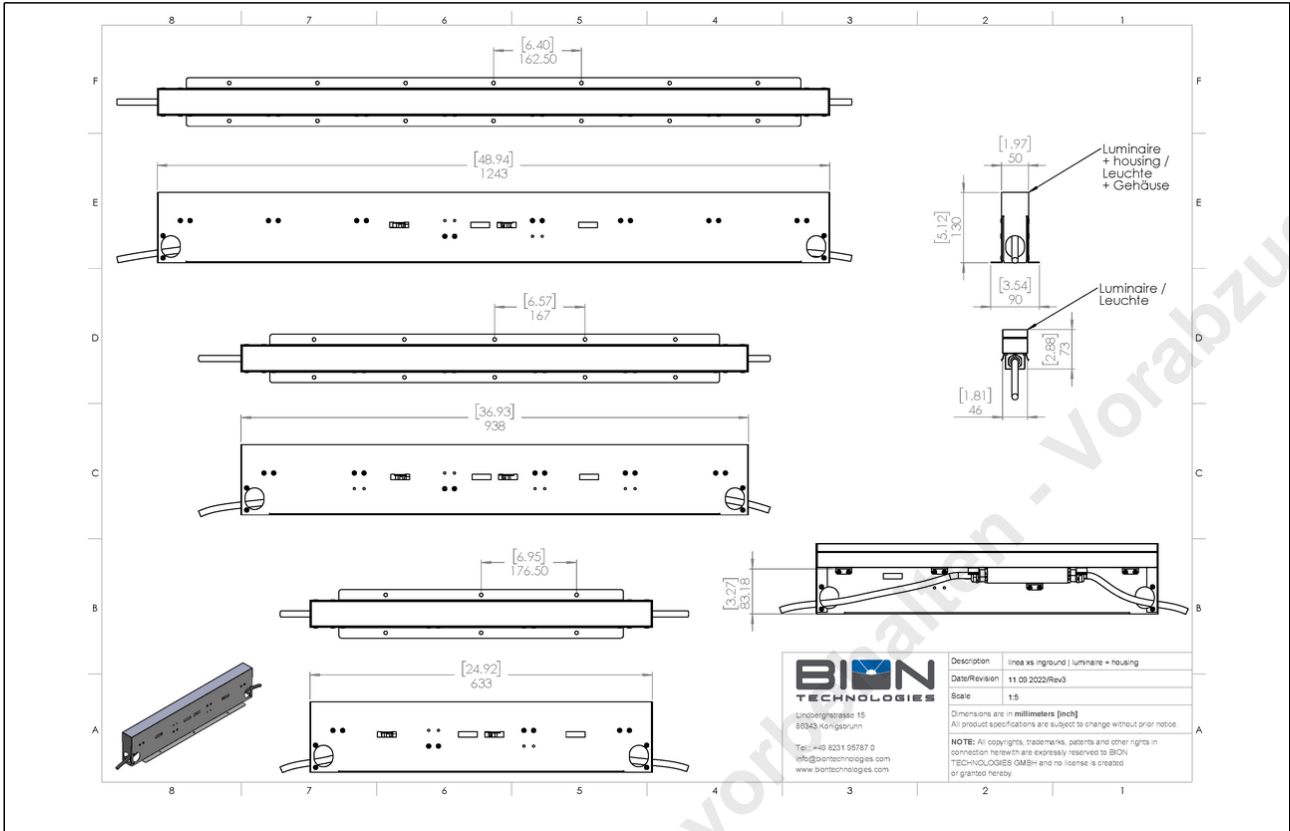

# Mounting

## 1. General

### Foundation

The customer should provide a proper foundation to achieve the maximum pressure load. The luminaire is mounted in a recess housing made of high-strength stainless steel (The installation housing to be ordered separately). The pressure load is transferred to the foundation by this housing. The foundation must be carried out on a firm subgrade. In order to obtain a firm stability, the recess housing has to be firmly concreted in. During the preparation of the foundation, proper drainage shall be provided, so that entering surface water can drain off.

### Soil condition

The luminaire should not have permanent contact with aggressive media. Aggressive media might be washed out of the soil and corrode the luminaire housing. In case of unknown soil composition, a soil analysis should be made before installation. Aggressive media that is outgoing from the ground surface might also affect the luminaire. Thus an overuse of deicing agents in the surroundings should be avoided. Parasitic current, occurring from outside, which is conducted by the luminaire into the soil, will cause corrosion damage. Suitable countermeasures have to be carried out.

## 2. Installation Soft Ground / Paving stones

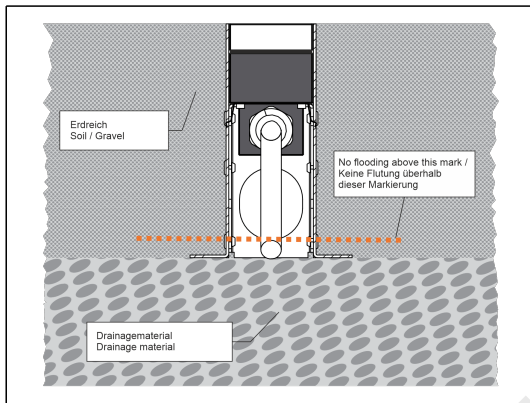

- Gravel dust is not an appropriate drainage material! Over the time it hardens and the drainage capacity will be reduced.
- Proper drainage material must support the entire length in order for it to reach 500 kg / 1100 lbs resistance.
- Test your drainage system after installing the installation housing but before installing your fixtures! The equivalent quantity of water to the volume of the installation housing must drain completely in 30 minutes.

## 3. Installation in Concrete

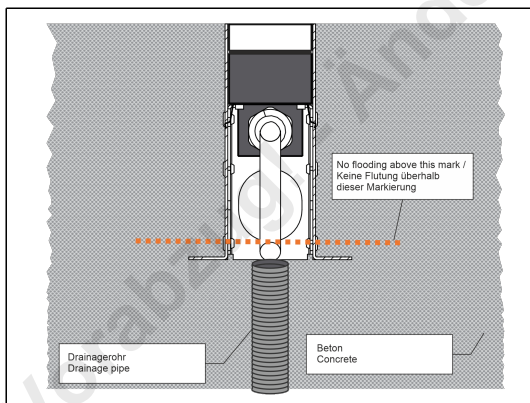

Test your drainage system after installing the installation housing but before installing your fixtures! The equivalent quantity of water to the volume of the installation housing must drain completely in 30 minutes.

# Commissioning

## 1. EXT - Wire assignment

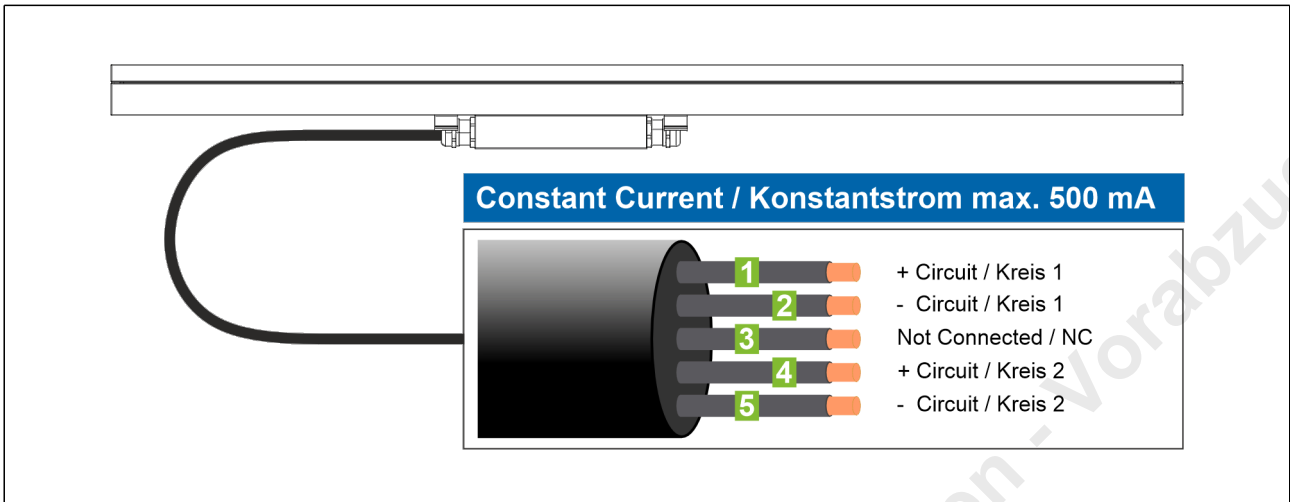

**Warning**

Disconnect the system from the primary supply voltage before carrying out installation and maintenance work.

Securing against restarting

Wait until all charged components are discharged. Possibly discharged by short circuit itself.

**Failure to do so may result in permanent damage to the fixture!**

**IMPORTANT NOTICE!**

Never carry out or change the electrical connection under voltage!

Work only under voltage-free and completely discharged drivers!

The luminaire is **ONLY** designed for operation with a constant current driver with max. 500 mA.

Each string must be terminated with an end fixture or an end plug (do not plug under voltage).

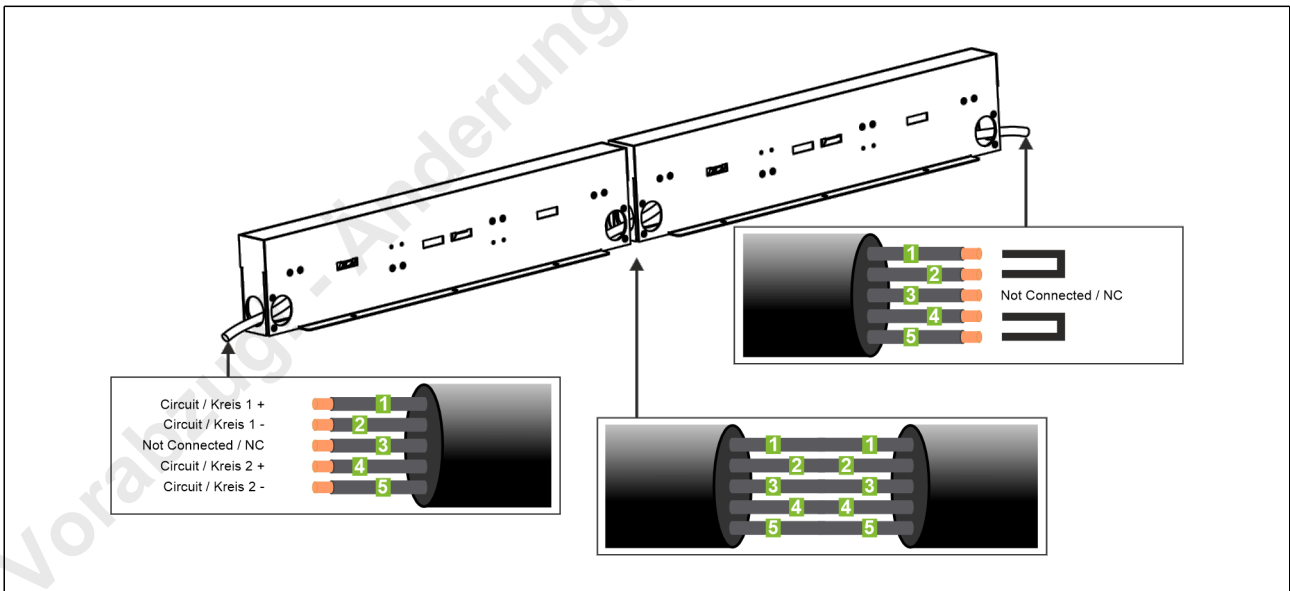



## 2. DMX / 0-10V - Wire assignment

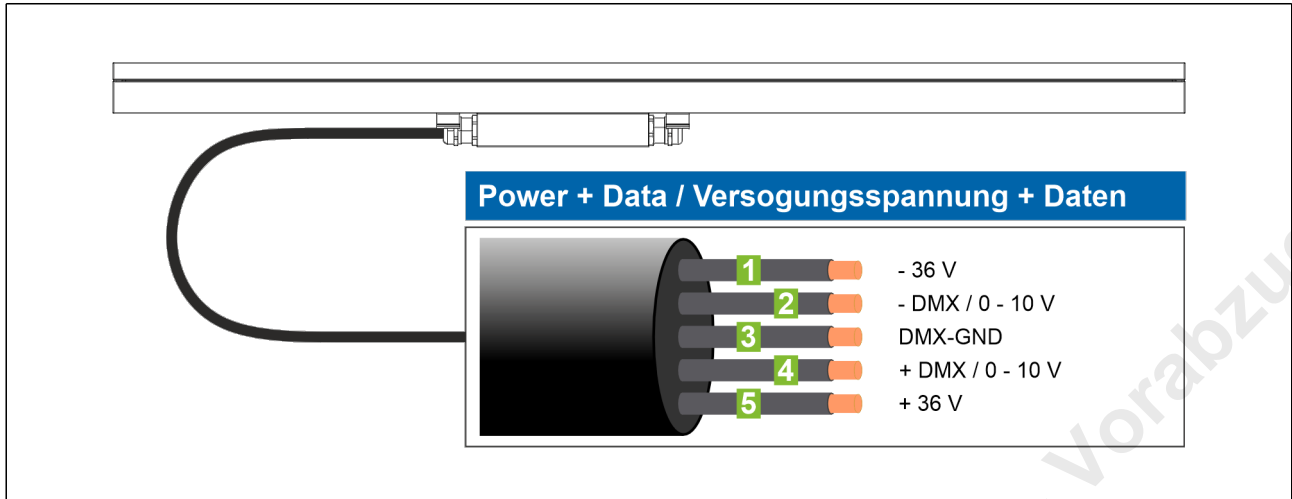

# Operation

## 1. Temperature management with integrated Driver (not in EXT-Version)

BION Technologies linea xs inground luminaires with integrated driver feature an active thermal management system to protect the luminaire against overheating. Sensors detect the state of the luminaire and regulate the light output accordingly. The adjustments of the power are made via an algorithm relatively over all channels, so that the desired light color is maintained as far as possible. In the event that the power reduction is not sufficient to protect the luminaire from permanent overtemperature damage, the luminaire switches off.

**IMPORTANT!** The shutdown is above the permissible ambient temperature (or surface temperature) during operation.

## 2. DMX - Modes of operation

Family / Familie	Luminaire Type / Leuchtentyp	Modes of operation / Betriebsmodi DMX Footprint
linea xs inground hp / mp / eco	pureWhite pureColor tunableWhite RGBW RGBA	Per fixture mode - 8bit  pureWhite / pureColor => DMX Footprint: 1 tunableWhite => DMX Footprint: 2 RGBW / RGBA=> DMX Footprint: 4

## 3. RDM - Remote Device Management Protocol



RDM is an extension of the DMX protocol defined by ANSI E1.20. The protocol is used to discover, configure, monitor, and manage BION Technologies luminaires through a DMX512 network.

BION Technologies luminaires require an RDM-compatible controller connected to the DMX512 network to read and alter fixture settings and request fixture data. BION Technologies recommends the scriptus XMT-350 as RDM-Interface to DMX512 networks.

Please see below the full list of the RDM functions BION Technologies luminaires support. These functions are generally referred to as Parameter IDs.

Parameter IDs	Get	Set
DISC_UNIQUE_BRANCH		
DISC_MUTE		
DISC_UN_MUTE		
SUPPORTED_PARAMETERS	✓	
DEVICE_INFO	✓	
DEVICE_MODEL_DESCRIPTION	✓	
MANUFACTURER_LABEL	✓	
DEVICE_LABEL	✓	✓
SOFTWARE_VERSION_LABEL	✓	
DMX_PERSONALITY	✓	✓
DMX_PERSONALITY_DESCRIPTION	✓	
DMX_START_ADDRESS	✓	✓
SENSOR_DEFINITION	✓	
SENSOR_VALUE	✓	
DEVICE_HOURS	✓	
DEVICE_POWER_CYCLES	✓	

## Maintenance

Clean device from dirt and residue regularly. Use solvent-free cleaning agents only and do not employ aggressive chemicals or high pressure cleaner. Operate device only after complete drying.

## Conformity



## Manufacturer



### Bion Technologies GmbH

Lindberghstrasse 15  
86343 Koenigsbrunn  
Tel: +49 (0)8231/95787-0  
Fax: +49 (0)8231/95787-29  
[www.biontechnologies.com](http://www.biontechnologies.com)  
[info@biontechnologies.com](mailto:info@biontechnologies.com)

YouTube: <http://www.youtube.com/BIONTECHNOLOGIES>

All rights reserved / Subject to change / Specifications may change without notice

## BEDIENUNGSANLEITUNG

# linea xs inground eco

pureWhite | pureColor

### Sicherheitshinweise



**Anschluss und Bedienung dieses Geräts sollte ausschließlich von qualifiziertem Fachpersonal in Übereinstimmung mit allen geltenden Vorschriften erfolgen.**

Lesen Sie zu Ihrer eigenen Sicherheit sorgfältig alle Hinweise und Montageschritte.

Installieren oder verwenden Sie die Leuchte erst, nachdem Sie die Installationsanweisungen und Sicherheitsetiketten gelesen und verstanden haben.

Bewahren Sie die Anleitung für Wartungs- oder Demontearbeiten auf.

Der elektrische Anschluss darf nur von fachkundigem Personal durchgeführt werden, das hierfür ausgebildet und befugt ist.

**WARNUNG** - Gefahr eines elektrischen Schlages!

Betreiben Sie die Leuchte nur mit unbeschädigter Abdeckscheibe, Gehäuse und Versorgungsleitungen.

Die Lichtquelle (LED-Modul) dieser Leuchte ist nicht ersetzbar.

- Wenn die Lichtquelle ihr Lebensdauerende erreicht hat, ersetzen Sie die gesamte Leuchte.
- LED-Modul: Risikogruppe 1



## Lieferumfang

- Packen Sie alle Teile aus.
- Prüfen Sie den Verpackungsinhalt auf sichtbare Transportschäden.
- Prüfen Sie, ob der Verpackungsinhalt vollständig ist.

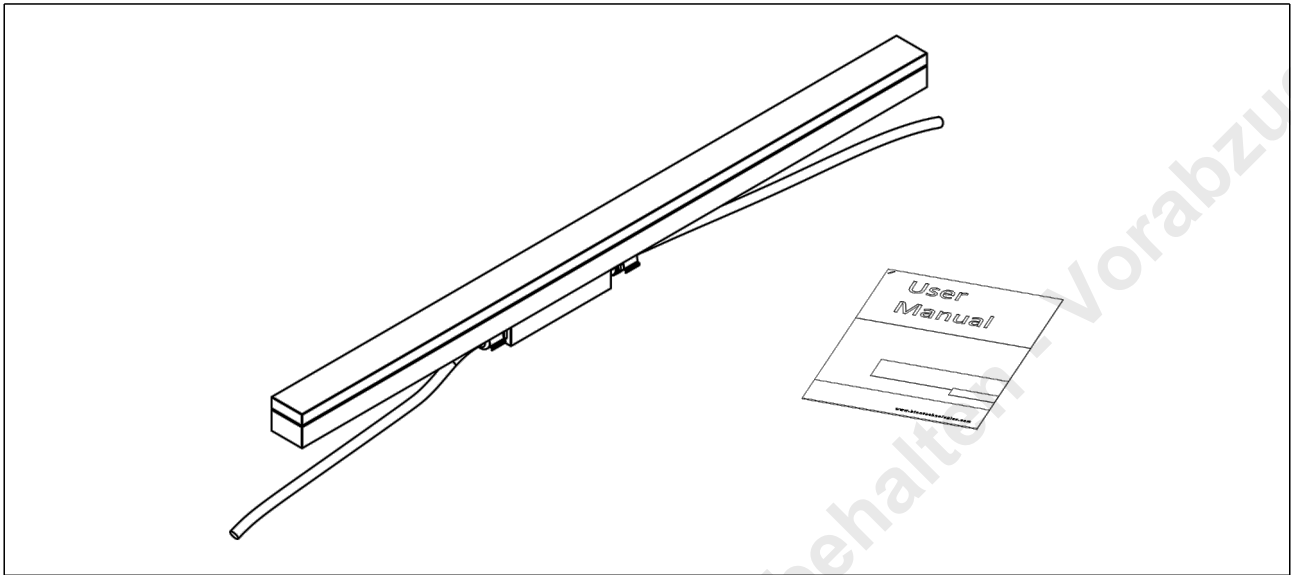









Im Lieferumfang enthalten:

- 1x Bion Technologies linea xs inground, gem. Spezifikation (Spezifikation kann von obigem Bild abweichen)
- 1x Bedienungsanleitung

Wenn Sie Transportschäden oder Unstimmigkeiten zwischen dem hier angegebenen Lieferumfang und Verpackungsinhalt feststellen, informieren Sie unverzüglich Ihre Verkaufsstelle.

## Technische Daten

Abmessungen	46 mm x 74 mm [B x H] 1.81 in x 2.91 in [B x H]
	Einbaugehäuse: 50 mm x 130 mm [B x H] 1.97 in x 5.12 in [B x H]
Leuchtenlängen	629 mm, 934 mm, 1239 mm 24.77 in, 36.78 in, 48.78 in
Leuchtentyp	  pureWhite pureColor
Farbtemperaturen pureWhite	2200 K, 2700 K, 3000 K, 3500 K, 4000 K * Projektbezogene Farbtemperaturen für pureWhite möglich
LED-Farben pureColor	Rot, Grün, Blau, Amber * Projektbezogene LED-Farben für pureColor möglich
Abstrahlwinkel	8°, 10°, 23°, 43°, 8° x 31° 10° x 42°, 12° x 60°, 14° x 100°, 30° x 60°, 60° x 30°
Lichtstrom	629 mm (24.77 in): 600 lm 934 mm (36.78 in): 900 lm 1239 mm (48.78 in): 1200 lm
Lichtquelle	629 mm (24.77 in): 16 LEDs 934 mm (36.78 in): 24 LEDs 1239 mm (48.78 in): 32 LEDs
Farbwiedergabeindex	R <sub>a</sub> >= 80
Entblendung	optional: <ul style="list-style-type: none"><li>internes Wabenraster</li><li>internes lineares Entblendungsraster</li></ul>
LED-Binning	
MacAdam-Ellipsen Binning	3
Dimmung	Nicht dimmbar   Dimmbar (DALI , 0 - 10 V , DMX)

Eingangsspannung	Netzteil: extern   36 VDC EXT: Konstantstrom, max. 500 mA
Wirkleistungsaufnahme	629 mm (24.77 in): Max. 10 W 934 mm (36.78 in): Max. 15 W 1239 mm (48.78 in): Max. 20 W
Schutzklasse	II
Lagertemperatur	-40 °C / +80 °C   -40 °F / +176 °F
Betriebstemperatur	-40 °C / +40 °C   -40 °F / +104 °F
Einschalttemperatur	-25 °C / +40 °C   -13 °F / +104 °F
Lebensdauer [L70]	65'000 h @ 25 °C (77 °F)   40'000 h @ 40 °C (104 °F)
Gehäuse	Aluminum-Strangpressprofil
Gehäusefarbe(n)	 Schwarz eloxiert
Linse	Gehärtetes Sicherheitsglas, extra weiß
Schutzart	IP67
Umgebung	 indoor  outdoor
Schlagschutz	IK09
Zulassungen	  



# Technische Zeichnung

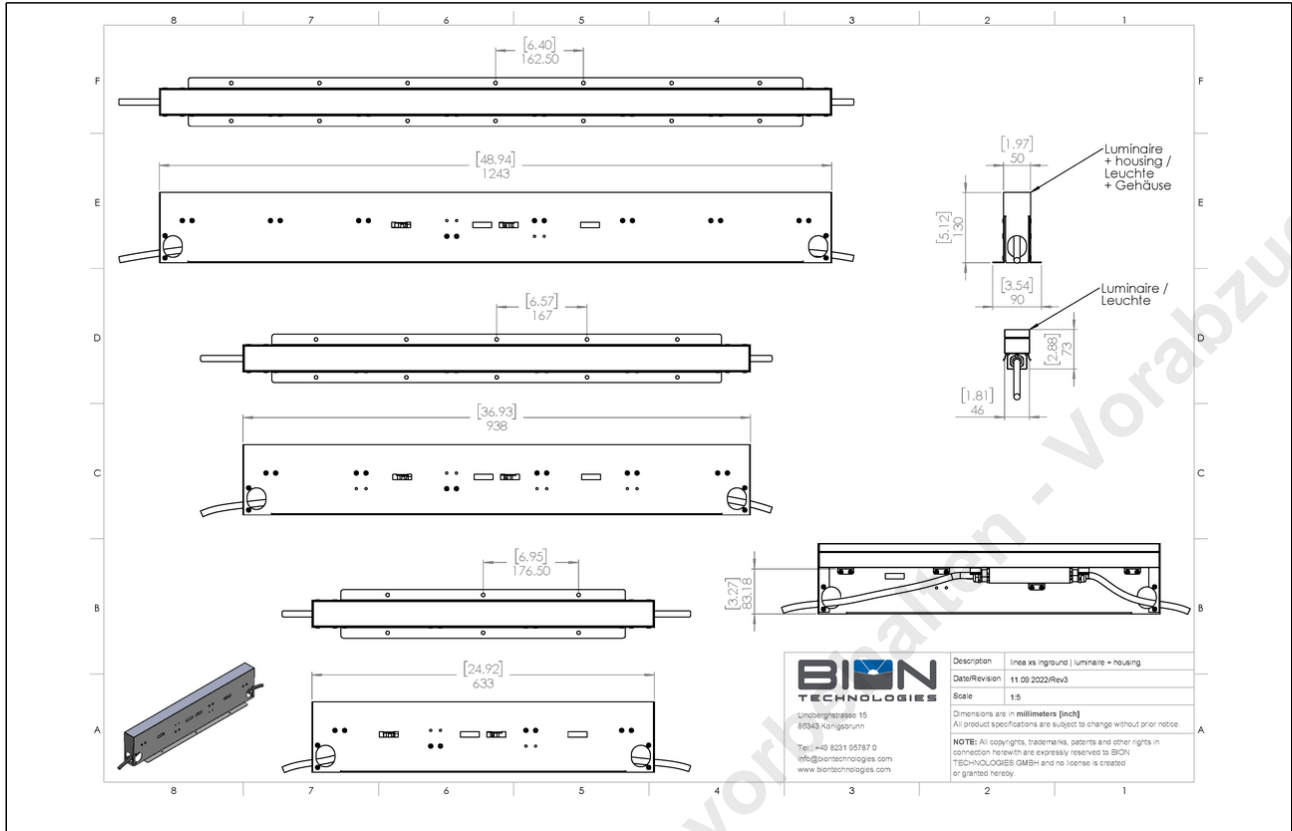



# Inbetriebnahme

## 1. EXT - Aderbelegung

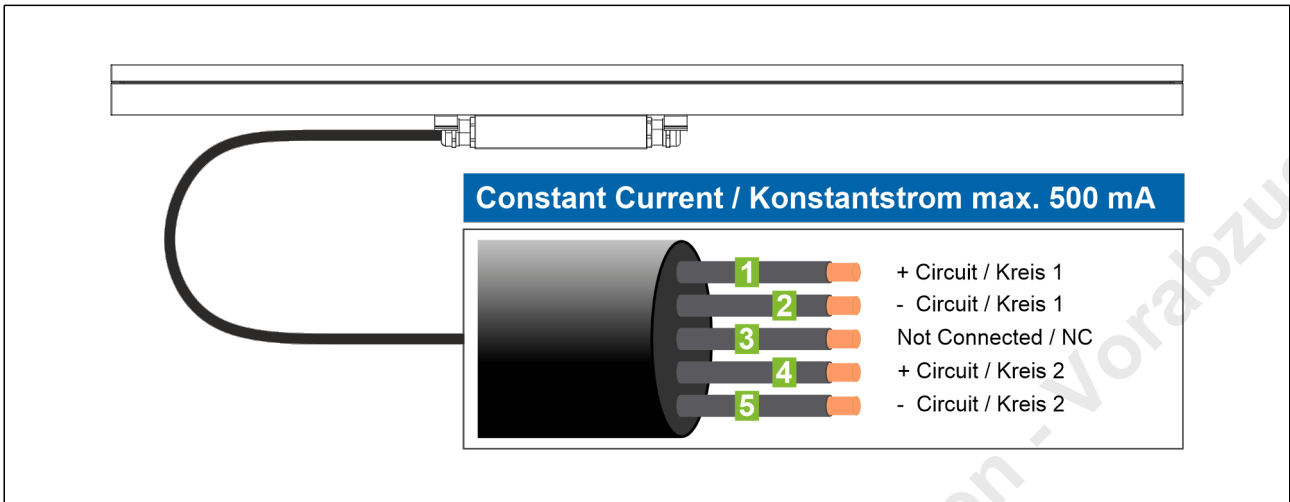

**Warnhinweis**

Vor Installations- und Wartungsarbeiten das System von der primären Versorgungsspannung trennen.  
Sichern gegen Wiedereinschalten

Warten Sie, bis alle elektronischen Bauteile entladen sind. Eventuell durch Kurzschluss selbst entladen

Bei Nichtbeachtung kann es zu dauerhaften Schäden an der Leuchte kommen!

### WICHTIGER HINWEIS!

- Elektrisch Anschluss niemals unter Spannung durchführen oder Verändern!
- Arbeiten nur unter spannungsfreien u. vollständig entladenen Treibern durchführen!

Die Leuchte ist **NUR** für den Betrieb an einem **Konstantstromtreiber** mit max. 500 mA ausgelegt.

Jeder Strang muss mit einer Endleuchte oder einem Endstecker (nicht unter Spannung stecken) abgeschlossen werden.

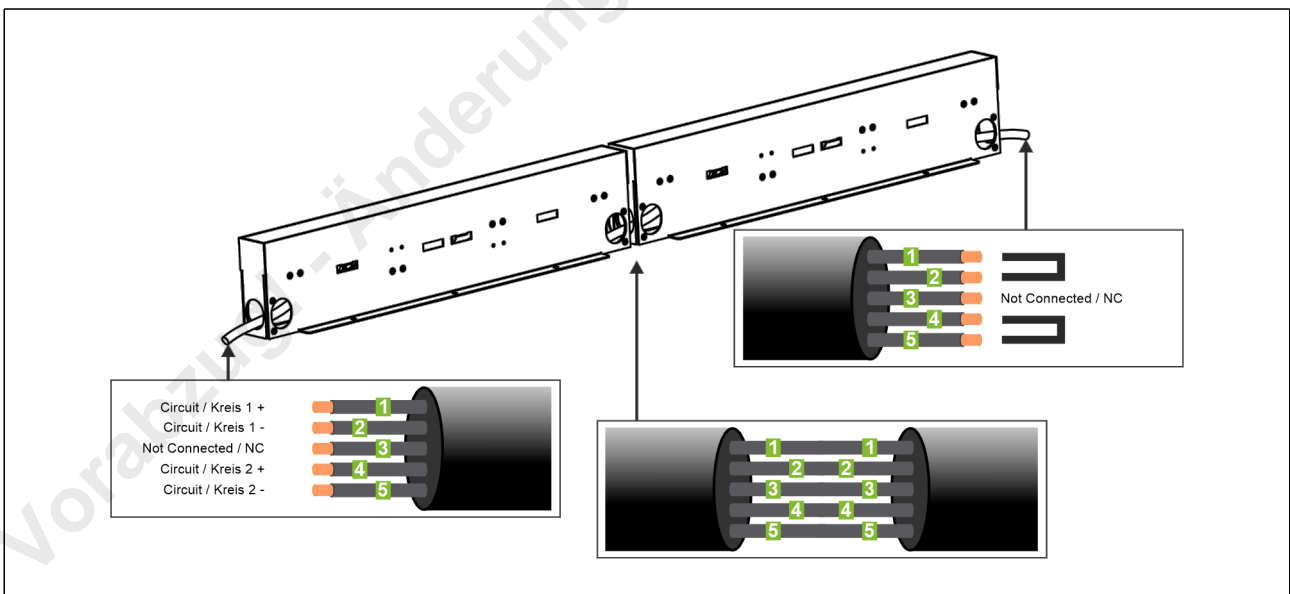

## 2. DMX / 0-10V - Aderbelegung

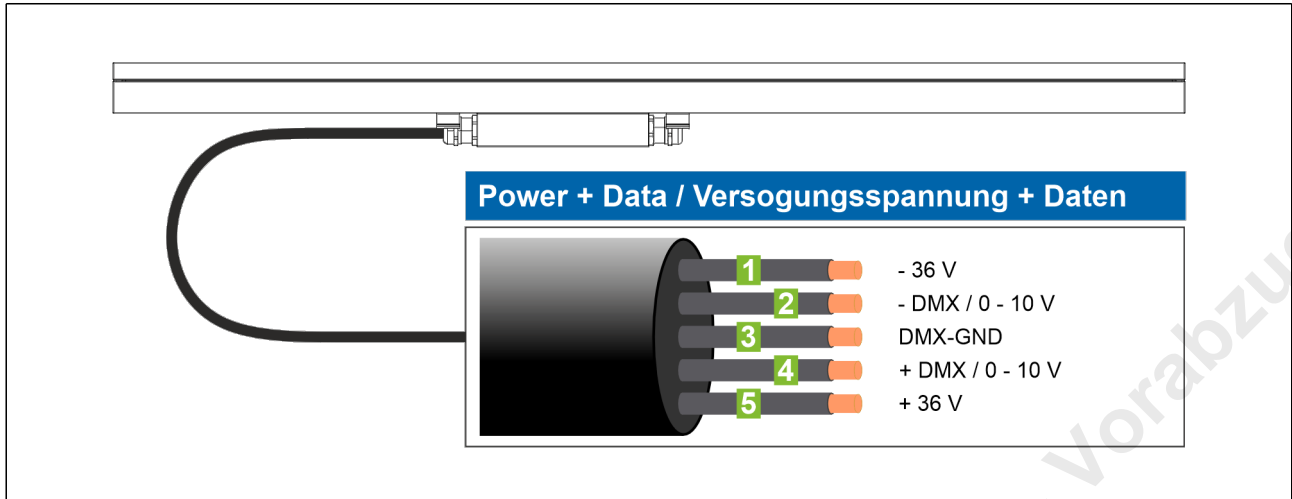

# Bedienungsanleitung

## 1. Temperaturmanagement mit integriertem Treiber (nicht bei EXT-Version)

BION Technologies linea xs inground mit integriertem Treiber verfügen über ein aktives thermisches Managementsystem zu Selbstschutz der Leuchte gegen Überhitzung. Hierbei werden über Sensoren der Zustand der Leuchte erfasst und die Lichtleistung entsprechend reguliert. Die Anpassungen der Leistung erfolgt über einen Algorithmus relativ über alle Kanäle, sodass die gewünschte Lichtfarbe weitestgehend erhalten bleibt. In dem Fall, dass die Leistungsreduktion nicht ausreicht die Leuchte vor einem nachhaltigen Übertemperaturschaden zu schützen, schaltet die Leuchte ab.

**WICHTIG!** Die Abschaltung liegt über der zulässigen Umgebungstemperatur (bzw. Oberflächentemperatur) im Betrieb.

## 2. DMX - Betriebsmodi

Family / Familie	Luminaire Type / Leuchtentyp	Modes of operation / Betriebsmodi DMX Footprint
linea xs inground hp / mp / eco	pureWhite pureColor tunableWhite RGBW RGBA	Per fixture mode - 8bit  pureWhite / pureColor => DMX Footprint: 1 tunableWhite => DMX Footprint: 2 RGBW / RGBA=> DMX Footprint: 4

## 3. RDM - Remote Device Management Protocol



RDM ist eine Erweiterung des von ANSI E1.20 definierten DMX-Protokolls. Das Protokoll wird zur Erkennung, Konfiguration, Überwachung und Verwaltung von BION Technologies Leuchten über ein DMX512-Netzwerk verwendet.

BION Technologies Leuchten benötigen einen RDM-kompatiblen Controller, der mit dem DMX512-Netzwerk verbunden ist, um Geräteeinstellungen zu lesen und zu ändern und Gerätedaten abzufragen. BION Technologies empfiehlt das scriptus XMT-350 als RDM-Interface zu DMX512-Netzwerken.

Im Folgenden finden Sie eine vollständige Liste der RDM-Funktionen, die von BION Technologies Leuchten unterstützt werden. Diese Funktionen werden allgemein als Parameter IDs bezeichnet.

Parameter IDs	Get	Set
DISC_UNIQUE_BRANCH		
DISC_MUTE		
DISC_UN_MUTE		
SUPPORTED_PARAMETERS	✓	
DEVICE_INFO	✓	
DEVICE_MODEL_DESCRIPTION	✓	
MANUFACTURER_LABEL	✓	
DEVICE_LABEL	✓	✓
SOFTWARE_VERSION_LABEL	✓	
DMX_PERSONALITY	✓	✓
DMX_PERSONALITY_DESCRIPTION	✓	
DMX_START_ADDRESS	✓	✓
SENSOR_DEFINITION	✓	
SENSOR_VALUE	✓	
DEVICE_HOURS	✓	
DEVICE_POWER_CYCLES	✓	

## Wartung + Pflege

Gerät regelmäßig mit einem feuchten Tuch reinigen. Verwenden Sie ausschließlich lösungsmittelfreie Reinigungsmittel und verwenden Sie keine Chemikalien.

## Konformität



## Hersteller



### Bion Technologies GmbH

Lindberghstrasse 15  
86343 Koenigsbrunn  
Tel: +49 (0)8231/95787-0  
Fax: +49 (0)8231/95787-29  
[www.biontechnologies.com](http://www.biontechnologies.com)  
[info@biontechnologies.com](mailto:info@biontechnologies.com)

YouTube: <http://www.youtube.com/BIONTECHNOLOGIES>

All rights reserved / Subject to change / Specifications may change without notice



Lindberghstrasse 15  
86343 Koenigsbrunn  
Tel: +49 (0)8231/95787-0  
Fax: +49 (0)8231/95787-29  
[www.biontechnologies.com](http://www.biontechnologies.com)  
[info@biontechnologies.com](mailto:info@biontechnologies.com)

YouTube: <http://www.youtube.com/user/BIONTECHNOLOGIES>

© 2022, BION TECHNOLOGIS GMBH  
All rights reserved / Subject to change / Specifications may change without notice