

linea xs hp



RGBW |





TECHNICAL DATASHEET

linea xs hp

RGBW |

Technical Data

Dimensions	46 mm x 57 mm [W x H] 1.80 in x 2.25 in [W x H]																
Standard Unit Lengths	324 mm, 477 mm, 629 mm, 782 mm, 934 mm, 1087 mm, 1239 mm 12.76 in, 18.78 in, 24.77 in, 30.79 in, 36.78 in, 42.80 in, 48.78 in																
Fixture Typ	 RGBW RGBA																
Color Temperatures W-Channel	2200 K, 2700 K, 3000 K, 4000 K * Project-specific LED-colors for RGBW/RGB available.																
Beam Angles	8°, 10°, 23°, 43°, 8° x 31° 10° x 42°, 12° x 60°, 14° x 100°, 30° x 60°, 60° x 30°																
Luminous Flux	<table border="0"> <tr><td>324 mm (12.76 in):</td><td>558 lm</td></tr> <tr><td>477 mm (18.78 in):</td><td>837 lm</td></tr> <tr><td>629 mm (24.77 in):</td><td>1116 lm</td></tr> <tr><td>782 mm (30.79 in):</td><td>1395 lm</td></tr> <tr><td>934 mm (36.78 in):</td><td>1674 lm</td></tr> <tr><td>1087 mm (42.8 in):</td><td>1953 lm</td></tr> <tr><td>1239 mm (48.78 in):</td><td>2232 lm</td></tr> </table>			324 mm (12.76 in):	558 lm	477 mm (18.78 in):	837 lm	629 mm (24.77 in):	1116 lm	782 mm (30.79 in):	1395 lm	934 mm (36.78 in):	1674 lm	1087 mm (42.8 in):	1953 lm	1239 mm (48.78 in):	2232 lm
324 mm (12.76 in):	558 lm																
477 mm (18.78 in):	837 lm																
629 mm (24.77 in):	1116 lm																
782 mm (30.79 in):	1395 lm																
934 mm (36.78 in):	1674 lm																
1087 mm (42.8 in):	1953 lm																
1239 mm (48.78 in):	2232 lm																
Light Source	<table border="0"> <tr><td>324 mm (12.76 in):</td><td>8 LEDs</td></tr> <tr><td>477 mm (18.78 in):</td><td>12 LEDs</td></tr> <tr><td>629 mm (24.77 in):</td><td>16 LEDs</td></tr> <tr><td>782 mm (30.79 in):</td><td>20 LEDs</td></tr> <tr><td>934 mm (36.78 in):</td><td>24 LEDs</td></tr> <tr><td>1087 mm (42.8 in):</td><td>28 LEDs</td></tr> <tr><td>1239 mm (48.78 in):</td><td>32 LEDs</td></tr> </table>			324 mm (12.76 in):	8 LEDs	477 mm (18.78 in):	12 LEDs	629 mm (24.77 in):	16 LEDs	782 mm (30.79 in):	20 LEDs	934 mm (36.78 in):	24 LEDs	1087 mm (42.8 in):	28 LEDs	1239 mm (48.78 in):	32 LEDs
324 mm (12.76 in):	8 LEDs																
477 mm (18.78 in):	12 LEDs																
629 mm (24.77 in):	16 LEDs																
782 mm (30.79 in):	20 LEDs																
934 mm (36.78 in):	24 LEDs																
1087 mm (42.8 in):	28 LEDs																
1239 mm (48.78 in):	32 LEDs																
Color Rendering Index	R _a >= 80																
Antiglare	optional: <ul style="list-style-type: none"> ▪ Hex louver (internal) ▪ Linear louver (internal) 																
LED-Binning																	
MacAdam Ellipses Binning	3																
Control	DMX																

Input Voltage	Power supply: external 36 VDC		
Power Consumption	324 mm (12.76 in):	Max. 14 W	
	477 mm (18.78 in):	Max. 21 W	
	629 mm (24.77 in):	Max. 28 W	
	782 mm (30.79 in):	Max. 35 W	
	934 mm (36.78 in):	Max. 42 W	
	1087 mm (42.8 in):	Max. 49 W	
	1239 mm (48.78 in):	Max. 56 W	
Protection Class	II		
Storage Temperatur	-40 °C / +80 °C -40 °F / +176 °F		
Operating Temperature	-40 °C / +40 °C -40 °F / +104 °F		
Start-up Temperature	-25 °C / +40 °C -13 °F / +104 °F		
Lumen Maintenance [L70]	65'000 h @ 25 °C (77 °F) 40'000 h @ 40 °C (104 °F)		
Housing	Aluminum extruded profile		
Housing Color(s)			
	Aluminium anodized (Standard)	Black anodized	
Lens	Tempered safety glass, extra white		
Weight	324 mm (12.76 in):	1,5 kg (3.31 lbs)	
	629 mm (24.77 in):	2,1 kg (4.63 lbs)	
	934 mm (36.78 in):	3,2 kg (7.05 lbs)	
	1239 mm (48.78 in):	4,4 kg (9.70 lbs)	
Ingress Protection	IP66		
Environment			
	indoor	outdoor	
Impact Protection	IK08		
Certification			

Beam Angles

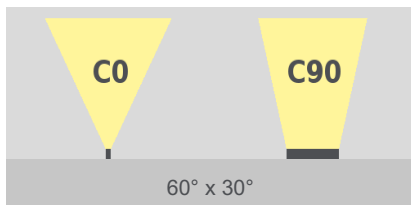
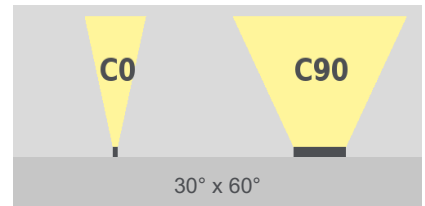
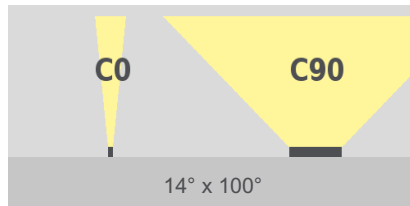
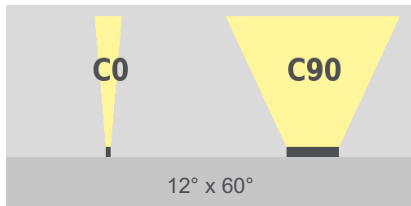
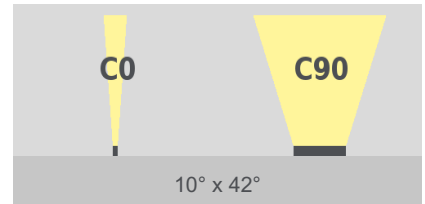
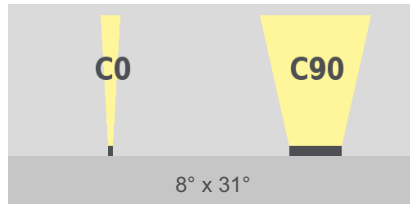
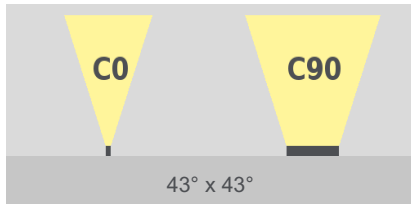
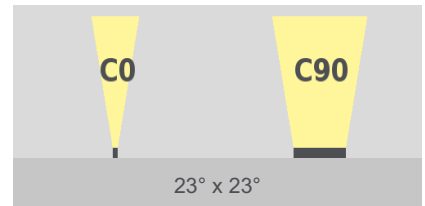
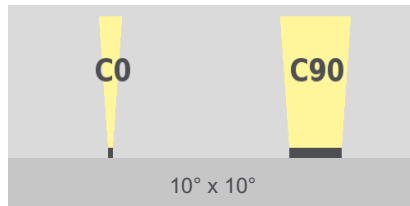
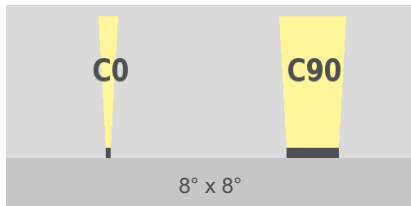

Engineering Drawing

 Lindberghstrasse 15, 86343 Königsdorf Tel. +49 8231 85767 0 info@biontechnologies.com www.biontechnologies.com	Description:	linea xs
	Date/Rev.:	16.06.2019/01
<small>Dimensions are in millimeters (mm) All product specifications are subject to change without prior notice. NOTE: All copyrights, trademarks, patents and other rights in connection herewith are expressly reserved to the company BION TECHNOLOGIES GMBH and no license is created hereby.</small>		

Project	Fixture#	Date
		Firm



Ordering Information

Choose the option that suits your needs and write its corresponding code on the appropriate line to form the product code.

LIN-XS-HP-	DIM-DMX								- Y01																																																																																																		
TYP - LUMINOUS COLOR	DIMMING	FIXTURE LENGTH	BEAM ANGLE	HOUSING COLOR	GLARE PROTECTION	WIRING CONFIGURATION	LEADERCABLE LENGTH	MOUNTING OPTION																																																																																																			
<table border="1"> <thead> <tr> <th colspan="2">TYP - LUMINOUS COLOR</th> </tr> </thead> <tbody> <tr><td>RGBW22</td><td>RGBW - 2200 K</td></tr> <tr><td>RGBW27</td><td>RGBW - 2700 K</td></tr> <tr><td>RGBW30</td><td>RGBW - 3000 K</td></tr> <tr><td>RGBW40</td><td>RGBW - 4000 K</td></tr> <tr><td>RGBA</td><td>RGBA</td></tr> </tbody> </table>	TYP - LUMINOUS COLOR		RGBW22	RGBW - 2200 K	RGBW27	RGBW - 2700 K	RGBW30	RGBW - 3000 K	RGBW40	RGBW - 4000 K	RGBA	RGBA	<table border="1"> <thead> <tr> <th colspan="2">DIMMING</th> </tr> </thead> <tbody> <tr><td>DMX</td><td>Dimmable - DMX</td></tr> </tbody> </table>	DIMMING		DMX	Dimmable - DMX	<table border="1"> <thead> <tr> <th colspan="2">FIXTURE LENGTH</th> </tr> </thead> <tbody> <tr><td>324</td><td>324 mm / 12.76 in</td></tr> <tr><td>477</td><td>477 mm / 18.78 in</td></tr> <tr><td>629</td><td>629 mm / 24.76 in</td></tr> <tr><td>782</td><td>782 mm / 30.79 in</td></tr> <tr><td>934</td><td>934 mm / 36.77 in</td></tr> <tr><td>1087</td><td>1087 mm / 42.8 in</td></tr> <tr><td>1239</td><td>1239 mm / 48.78 in</td></tr> </tbody> </table>	FIXTURE LENGTH		324	324 mm / 12.76 in	477	477 mm / 18.78 in	629	629 mm / 24.76 in	782	782 mm / 30.79 in	934	934 mm / 36.77 in	1087	1087 mm / 42.8 in	1239	1239 mm / 48.78 in	<table border="1"> <thead> <tr> <th colspan="2">BEAM ANGLE</th> </tr> </thead> <tbody> <tr><td>8X8</td><td>8° x 8°</td></tr> <tr><td>10X10</td><td>10° x 10°</td></tr> <tr><td>23X23</td><td>23° x 23°</td></tr> <tr><td>43X43</td><td>43° x 43°</td></tr> <tr><td>8X31</td><td>8° x 31°</td></tr> <tr><td>10X42</td><td>10° x 42°</td></tr> <tr><td>12X60</td><td>12° x 60°</td></tr> <tr><td>14X100</td><td>14° x 100°</td></tr> <tr><td>30X60</td><td>30° x 60°</td></tr> <tr><td>60X30</td><td>60° x 30°</td></tr> </tbody> </table>	BEAM ANGLE		8X8	8° x 8°	10X10	10° x 10°	23X23	23° x 23°	43X43	43° x 43°	8X31	8° x 31°	10X42	10° x 42°	12X60	12° x 60°	14X100	14° x 100°	30X60	30° x 60°	60X30	60° x 30°	<table border="1"> <thead> <tr> <th colspan="2">HOUSING COLOR</th> </tr> </thead> <tbody> <tr><td>AA</td><td>Aluminium anodized (Standard)</td></tr> <tr><td>BA</td><td>Black anodized</td></tr> </tbody> </table>	HOUSING COLOR		AA	Aluminium anodized (Standard)	BA	Black anodized	<table border="1"> <thead> <tr> <th colspan="2">GLARE PROTECTION</th> </tr> </thead> <tbody> <tr><td>OP</td><td>No glare protection</td></tr> <tr><td>HL</td><td>Hex louver (internal)</td></tr> <tr><td>LL0</td><td>Linear louver (internal)</td></tr> </tbody> </table>	GLARE PROTECTION		OP	No glare protection	HL	Hex louver (internal)	LL0	Linear louver (internal)	<table border="1"> <thead> <tr> <th colspan="2">WIRING CONFIGURATION</th> </tr> </thead> <tbody> <tr><td>IOCC</td><td>IN/OUT with Connector</td></tr> <tr><td>IXCX</td><td>only IN with Connector</td></tr> <tr><td>IOOC</td><td>IN open end / OUT socket</td></tr> <tr><td>IOOO</td><td>IN/OUT with open ends</td></tr> <tr><td>IXOX</td><td>only IN with open ends</td></tr> </tbody> </table>	WIRING CONFIGURATION		IOCC	IN/OUT with Connector	IXCX	only IN with Connector	IOOC	IN open end / OUT socket	IOOO	IN/OUT with open ends	IXOX	only IN with open ends	<table border="1"> <thead> <tr> <th colspan="2">LEADERCABLE LENGTH</th> </tr> </thead> <tbody> <tr><td>ETE</td><td>End to end - wiring</td></tr> <tr><td>003</td><td>+ 30 cm (ca. 1 ft)</td></tr> <tr><td>006</td><td>+ 60 cm (ca. 2 ft)</td></tr> <tr><td>009</td><td>+ 90 cm (ca. 3 ft)</td></tr> <tr><td>012</td><td>+ 1,2 m (ca. 4 ft)</td></tr> </tbody> </table>	LEADERCABLE LENGTH		ETE	End to end - wiring	003	+ 30 cm (ca. 1 ft)	006	+ 60 cm (ca. 2 ft)	009	+ 90 cm (ca. 3 ft)	012	+ 1,2 m (ca. 4 ft)	<table border="1"> <thead> <tr> <th colspan="2">MOUNTING OPTION</th> </tr> </thead> <tbody> <tr><td>ND</td><td>without bracket</td></tr> <tr><td>BS</td><td>Universal mounting bracket</td></tr> </tbody> </table>	MOUNTING OPTION		ND	without bracket	BS	Universal mounting bracket	
TYP - LUMINOUS COLOR																																																																																																											
RGBW22	RGBW - 2200 K																																																																																																										
RGBW27	RGBW - 2700 K																																																																																																										
RGBW30	RGBW - 3000 K																																																																																																										
RGBW40	RGBW - 4000 K																																																																																																										
RGBA	RGBA																																																																																																										
DIMMING																																																																																																											
DMX	Dimmable - DMX																																																																																																										
FIXTURE LENGTH																																																																																																											
324	324 mm / 12.76 in																																																																																																										
477	477 mm / 18.78 in																																																																																																										
629	629 mm / 24.76 in																																																																																																										
782	782 mm / 30.79 in																																																																																																										
934	934 mm / 36.77 in																																																																																																										
1087	1087 mm / 42.8 in																																																																																																										
1239	1239 mm / 48.78 in																																																																																																										
BEAM ANGLE																																																																																																											
8X8	8° x 8°																																																																																																										
10X10	10° x 10°																																																																																																										
23X23	23° x 23°																																																																																																										
43X43	43° x 43°																																																																																																										
8X31	8° x 31°																																																																																																										
10X42	10° x 42°																																																																																																										
12X60	12° x 60°																																																																																																										
14X100	14° x 100°																																																																																																										
30X60	30° x 60°																																																																																																										
60X30	60° x 30°																																																																																																										
HOUSING COLOR																																																																																																											
AA	Aluminium anodized (Standard)																																																																																																										
BA	Black anodized																																																																																																										
GLARE PROTECTION																																																																																																											
OP	No glare protection																																																																																																										
HL	Hex louver (internal)																																																																																																										
LL0	Linear louver (internal)																																																																																																										
WIRING CONFIGURATION																																																																																																											
IOCC	IN/OUT with Connector																																																																																																										
IXCX	only IN with Connector																																																																																																										
IOOC	IN open end / OUT socket																																																																																																										
IOOO	IN/OUT with open ends																																																																																																										
IXOX	only IN with open ends																																																																																																										
LEADERCABLE LENGTH																																																																																																											
ETE	End to end - wiring																																																																																																										
003	+ 30 cm (ca. 1 ft)																																																																																																										
006	+ 60 cm (ca. 2 ft)																																																																																																										
009	+ 90 cm (ca. 3 ft)																																																																																																										
012	+ 1,2 m (ca. 4 ft)																																																																																																										
MOUNTING OPTION																																																																																																											
ND	without bracket																																																																																																										
BS	Universal mounting bracket																																																																																																										

* Project-specific options are available - Please contact our Sales Representative for further information.



Lindberghstrasse 15
86343 Koenigsbrunn
Tel: +49 (0)8231/95787-0
Fax: +49 (0)8231/95787-29
www.biontechnologies.com
info@biontechnologies.com

YouTube: <http://www.youtube.com/user/BIONTECHNOLOGIES>

© 2024, BION TECHNOLOGIS GMBH
All rights reserved / Subject to change / Specifications may change without notice